

DATA SHEET

BLV97CE UHF power transistor

Product specification

March 1993

UHF power transistor

BLV97CE

FEATURES

- Internal input matching to achieve high power gain
- Ballasting resistors for an optimum temperature profile
- Gold metallization ensures excellent reliability

DESCRIPTION

NPN silicon planar epitaxial transistor in a SOT171 envelope, intended for common emitter, class-AB operation in radio transmitters for the 960 MHz communications band. The transistor has a 6-lead flange envelope, with a ceramic cap. All leads are isolated from the flange.

QUICK REFERENCE DATA

RF performance up to $T_h = 25\text{ }^\circ\text{C}$ in a common emitter class-AB circuit.

MODE OF OPERATION	f (MHz)	V_{CE} (V)	P_L (W)	G_P (dB)	η_c (%)
c.w. class-AB	960	24	35	> 7	> 50

PINNING - SOT171A

PIN	SYMBOL	DESCRIPTION
1	e	emitter
2	e	emitter
3	b	base
4	c	collector
5	e	emitter
6	e	emitter

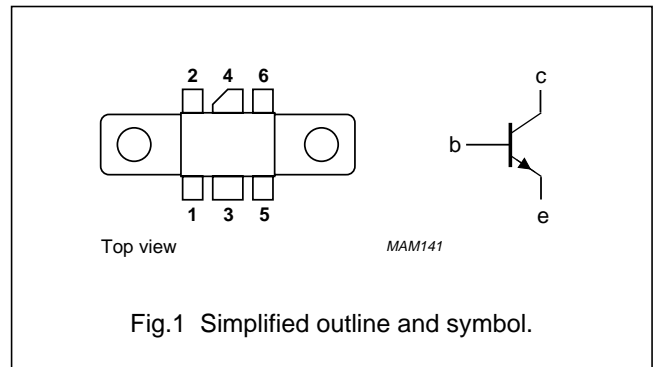

WARNING	
Product and environmental safety - toxic materials	
This product contains beryllium oxide. The product is entirely safe provided that the BeO disc is not damaged. All persons who handle, use or dispose of this product should be aware of its nature and of the necessary safety precautions. After use, dispose of as chemical or special waste according to the regulations applying at the location of the user. It must never be thrown out with the general or domestic waste.	

UHF power transistor

BLV97CE

LIMITING VALUES

Limiting values in accordance with the Absolute Maximum System (IEC 134)

SYMBOL	PARAMETER	CONDITIONS	MIN.	MAX.	UNIT
V_{CBO}	collector base voltage	open emitter	–	50	V
V_{CEO}	collector emitter voltage	open base	–	27	V
V_{EBO}	emitter base voltage	open collector	–	3.5	V
I_C	collector current	DC or average	–	3	A
I_{CM}	collector current	peak value $f > 1$ MHz	–	9	A
P_{tot}	total power dissipation	$f > 1$ MHz $T_{mb} = 25$ °C	–	70	W
T_{stg}	storage temperature		–65	150	°C
T_j	operating junction temperature		–	200	°C

THERMAL RESISTANCE

SYMBOL	PARAMETER	CONDITIONS	TYP.	MAX.	UNIT
R_{thj-mb}	from junction to mounting base (RF)		–	2.3	K/W
$R_{th mb-h}$	from mounting base to heatsink		–	0.4	K/W

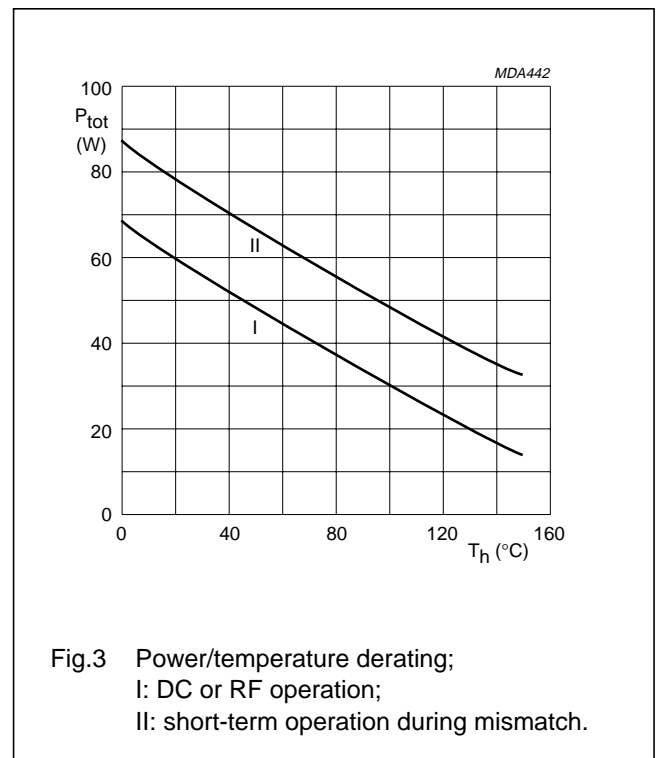
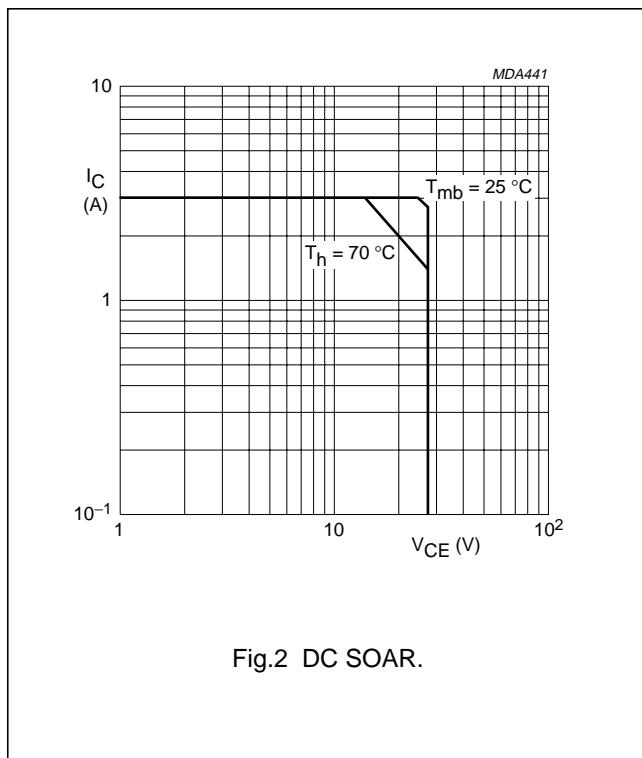

UHF power transistor

BLV97CE

CHARACTERISTICS

at $T_j = 25\text{ }^\circ\text{C}$ unless otherwise specified.

SYMBOL	PARAMETER	CONDITIONS	MIN.	TYP.	MAX.	UNIT
$V_{(BR)CBO}$	collector-base breakdown voltage	open emitter $I_C = 50\text{ mA}$	50	–	–	V
$V_{(BR)CEO}$	collector-emitter breakdown voltage	open base $I_C = 100\text{ mA}$	27	–	–	V
$V_{(BR)EBO}$	emitter-base breakdown voltage	open collector $I_E = 10\text{ mA}$	3.5	–	–	V
I_{CES}	collector leakage current	$V_{BE} = 0$ $V_{CE} = 27\text{ V}$	–	–	10	mA
h_{FE}	DC current gain	$I_C = 2\text{ A}$ $V_{CE} = 20\text{ V}$	15	–	–	
C_c	collector capacitance at $f = 1\text{ MHz}$	$I_E = I_e = 0$ $V_{CB} = 25\text{ V}$	–	44	–	pF
C_{re}	feedback capacitance at $f = 1\text{ MHz}$	$I_C = 0$ $V_{CE} = 25\text{ V}$	–	30	–	pF
C_{cf}	collector-flange capacitance		–	2	–	pF

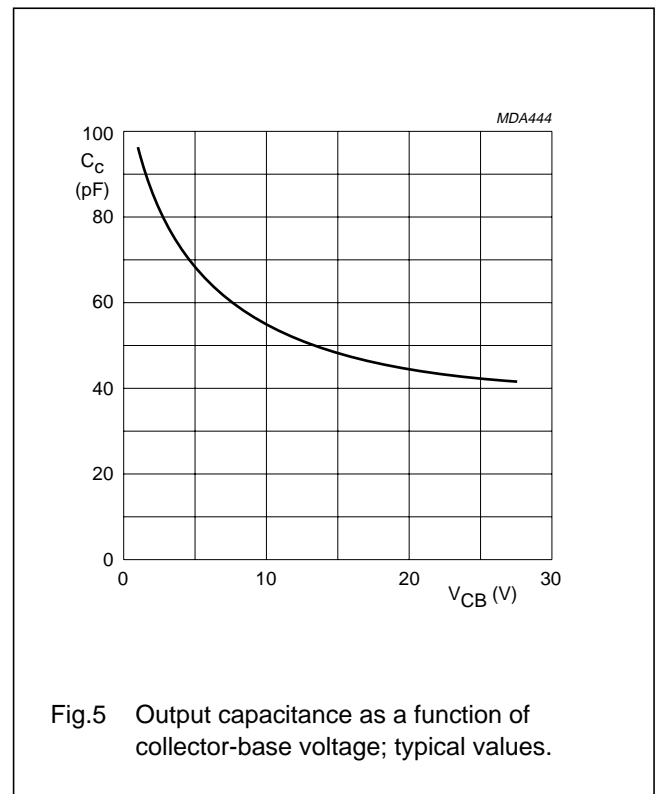
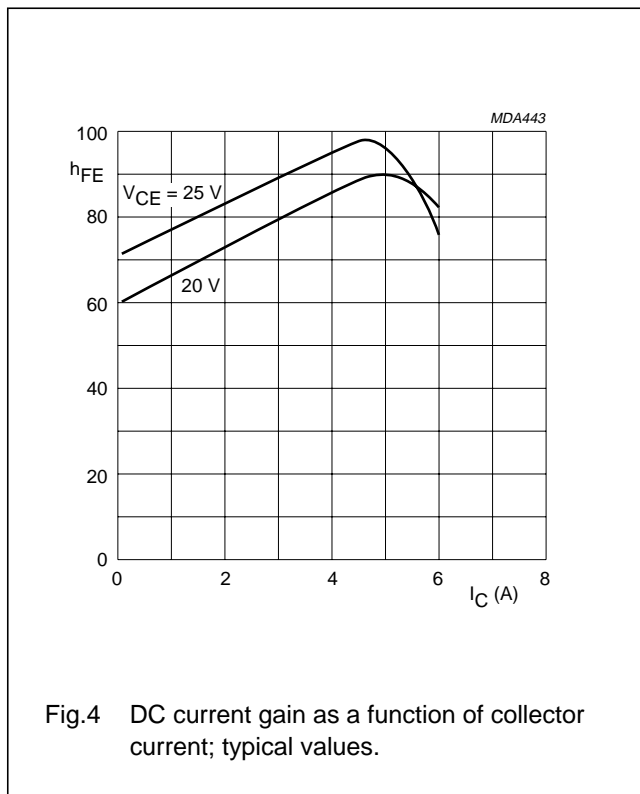

UHF power transistor

BLV97CE

APPLICATION INFORMATION

RF performance in a common emitter test circuit.

$T_h = 25\text{ }^\circ\text{C}$, $R_{th\text{ mb-h}} = 0.4\text{ K/W}$ unless otherwise specified.

MODE OF OPERATION	f (MHz)	V _{CE} (V)	I _{C(ZS)} (mA)	P _L (W)	G _P (dB)	η _c (%)
c.w. class-AB	960	24	60	35	> 7 typ. 8.5	> 50 typ. 55

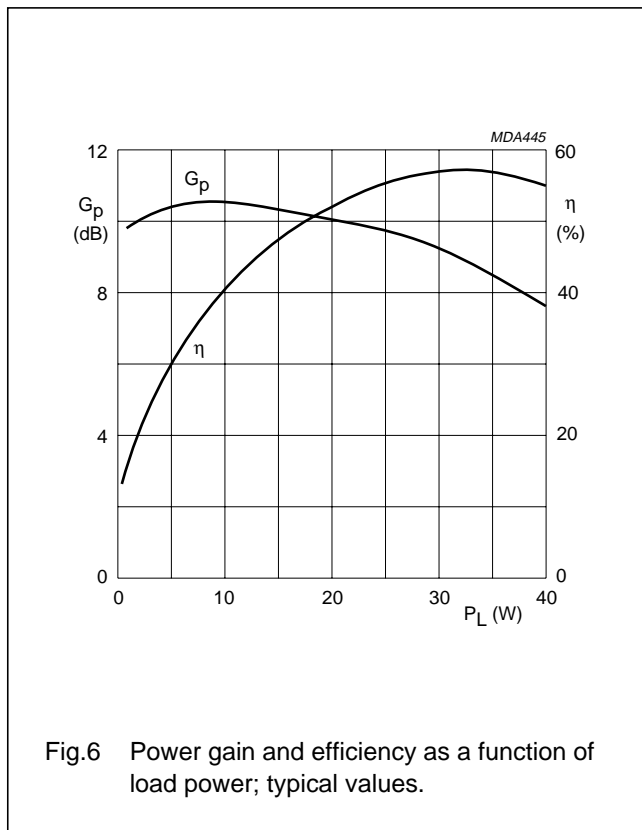

Fig.6 Power gain and efficiency as a function of load power; typical values.

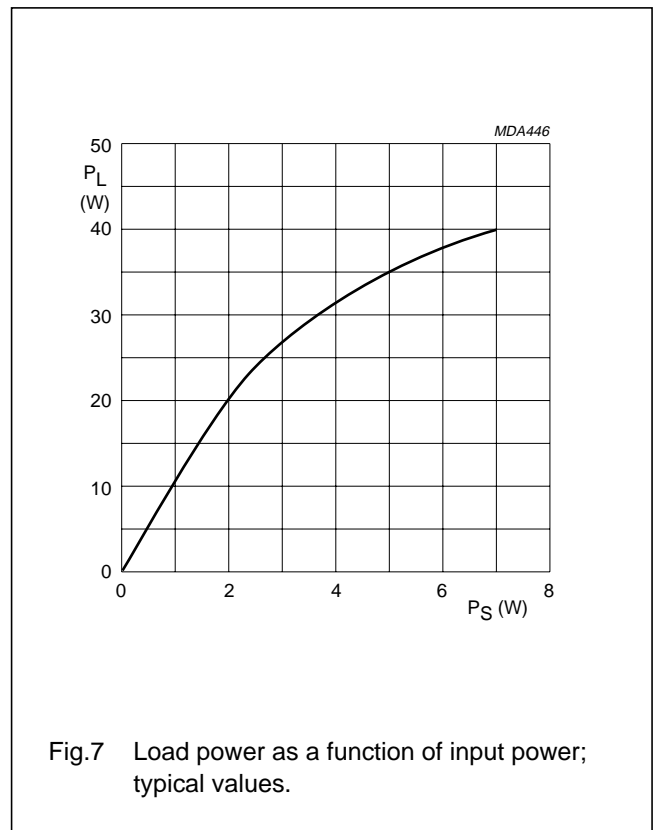

Fig.7 Load power as a function of input power; typical values.

Ruggedness in class-AB operation

The BLV97CE is capable of withstanding a load mismatch corresponding to $V_{SWR} = 50$ through all phases, under the following conditions: $V_{CE} = 24\text{ V}$; $I_{C(ZS)} = 120\text{ mA}$; $f = 960\text{ MHz}$ at rated output power.

UHF power transistor

BLV97CE

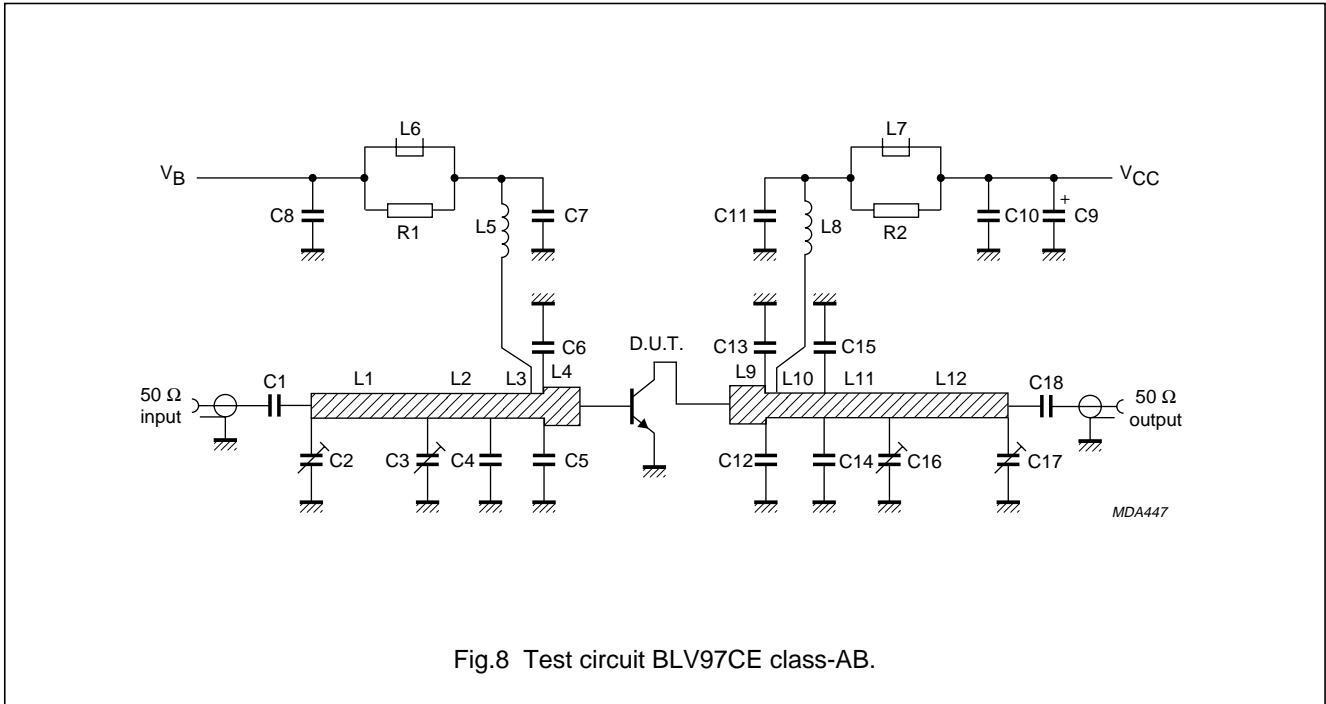

Fig.8 Test circuit BLV97CE class-AB.

UHF power transistor

BLV97CE

List of components (Fig.9)

DESIGNATION	DESCRIPTION	VALUE	DIMENSIONS	CATALOGUE NO.
C1, C18	multilayer ceramic chip capacitor note 1	33 pF		
C2, C3, C16, C17	film dielectric trimmer	1.4 to 5.5 pF		2222 809 09001
C5, C6	multilayer ceramic chip capacitor note 2	3.3 pF		
C7, C11	multilayer ceramic chip capacitor note 1	10 pF		
C8	multilayer ceramic chip capacitor	100 nF		
C9	35 V solid aluminium capacitor	2.2 μ F		2222 128 50228
C10	multilayer ceramic chip capacitor	3 \times 100 nF in parallel		
C12, C13	multilayer ceramic chip capacitor note 2	12 pF		
C14, C15	multilayer ceramic chip capacitor note 1	3.3 pF		
L1, L12	microstrip note 3	50 Ω	26 \times 2.4 mm	
L2, L3	microstrip note 3	50 Ω	9.5 \times 2.4 mm	
L4	microstrip note 3	42.6 Ω	6.0 \times 3.0 mm	
L5	3 turns enamelled 1 mm copper wire	30 nH	int. dia. 4 mm length 3 mm leads 2 \times 5 mm	
L6, L7	grade 3B ferroxcube wide-band RF choke			4312 020 36642
L8	4 turns enamelled 1 mm copper wire	45 nH	int. dia. 4 mm length 4 mm leads 2 \times 5 mm	
L9	microstrip note 3	42.6 Ω	4.0 \times 3.0 mm	
L10	microstrip note 3	50 Ω	9.0 \times 2.4 mm	
L11	microstrip note 3	50 Ω	13.5 \times 2.4 mm	
R1, R2	1 W metal film resistor	10 Ω		2322 153 51009

Notes

1. ATC capacitor type 100B or capacitor of the same quality.
2. ATC capacitor type 100A or capacitor of the same quality.
3. The microstrips are on a double copper-clad PCB with PTFE fibre-glass dielectric ($\epsilon_r = 2.2$); thickness $\frac{1}{32}$ inch.

UHF power transistor

BLV97CE

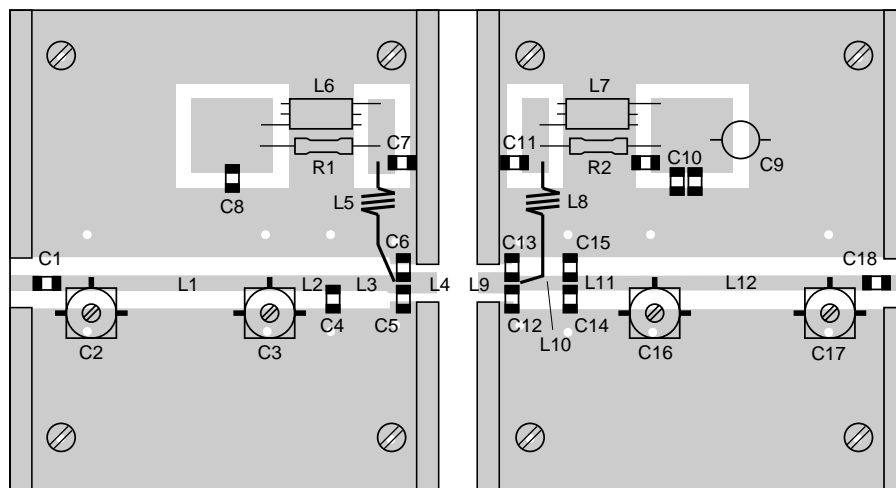
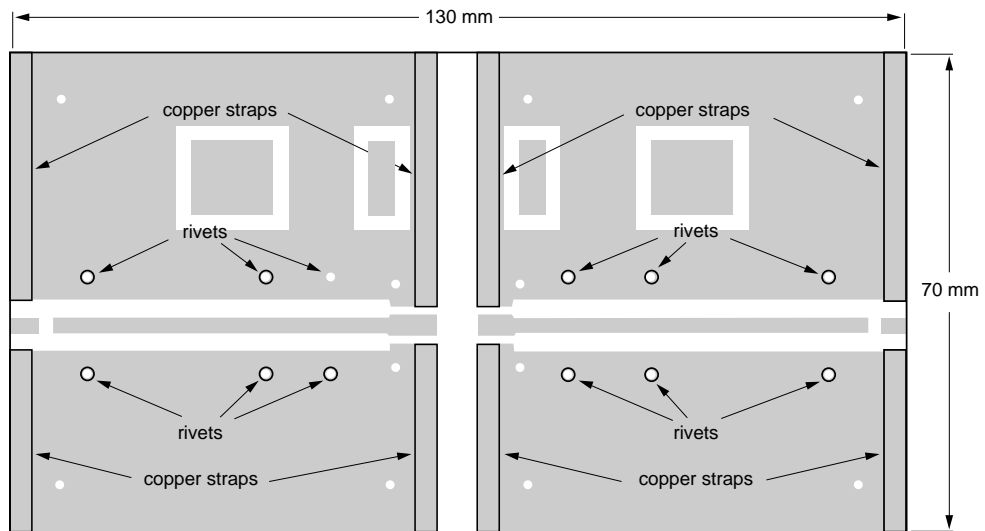

MDA448

The circuit and components are located on one side of the PTFE fibre-glass board, the other side being fully metallized, to serve as an earth. Earth connections are made by fixing screws, hollow rivets and copper straps around the board and under the emitters, to provide a direct contact between the component side and the ground plane.

Fig.9 Printed circuit board and component layout for 960 MHz test circuit.

UHF power transistor

BLV97CE

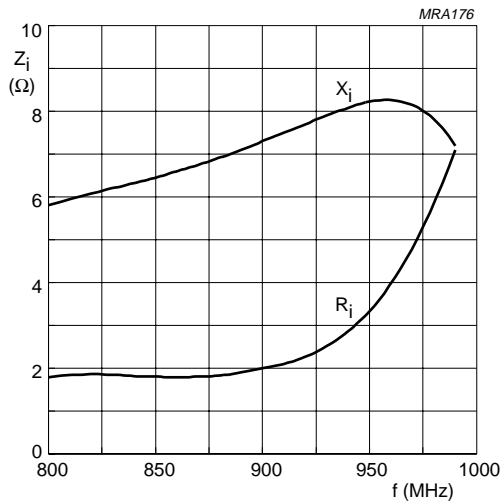

Fig.10 Input impedance; series components;
 $V_{CE} = 24 \text{ V}$; $P_L = 35 \text{ W}$; $R_{th\ mb-h} = 0.4 \text{ K/W}$;
 typical values.

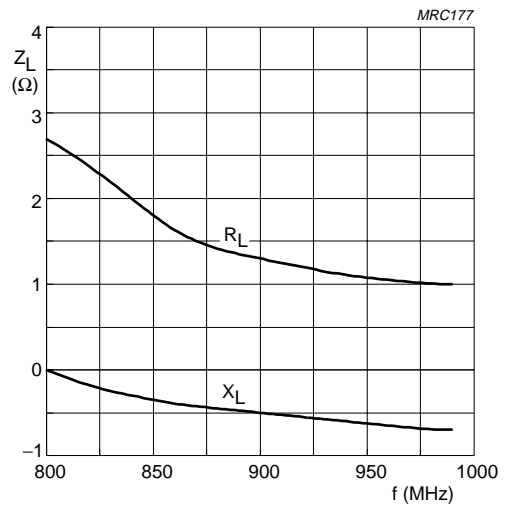

Fig.11 Load impedance; series components;
 $V_{CE} = 24 \text{ V}$; $P_L = 35 \text{ W}$; $R_{th\ mb-h} = 0.4 \text{ K/W}$;
 typical values.

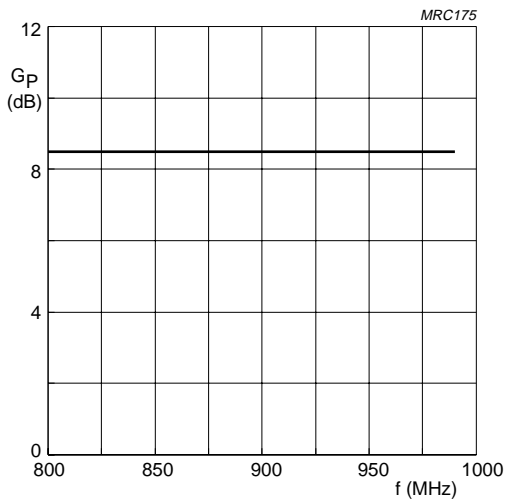

Fig.12 Power gain; class-AB operation;
 $V_{CE} = 24 \text{ V}$; $P_L = 35 \text{ W}$; $R_{th\ mb-h} = 0.4 \text{ K/W}$;
 typical values.

UHF power transistor

BLV97CE

PACKAGE OUTLINE

Flanged ceramic package; 2 mounting holes; 6 leads

SOT171A

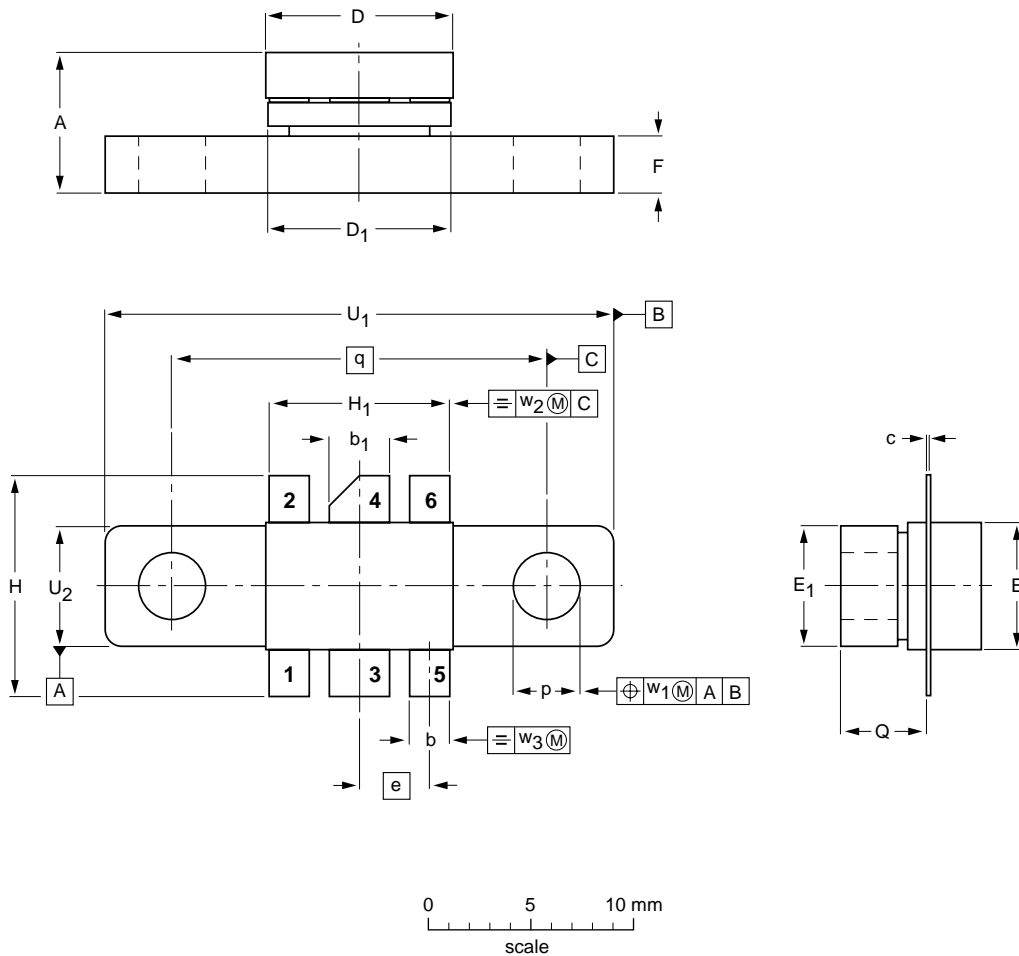

DIMENSIONS (millimetre dimensions are derived from the original inch dimensions)

UNIT	A	b	b ₁	c	D	D ₁	E	E ₁	e	F	H	H ₁	p	Q	q	U ₁	U ₂	w ₁	w ₂	w ₃
mm	6.81 6.07	2.15 1.85	3.20 2.89	0.16 0.07	9.25 9.04	9.30 8.99	5.95 5.74	6.00 5.70	3.58	3.05 2.54	11.31 10.54	9.27 9.01	3.43 3.17	4.32 4.11	18.42	24.90 24.63	6.00 5.70	0.51	1.02	0.26
inches	0.268 0.239	0.085 0.073	0.126 0.114	0.006 0.003	0.364 0.356	0.366 0.354	0.234 0.226	0.236 0.224	0.140	0.120 0.100	0.445 0.415	0.365 0.355	0.135 0.125	0.170 0.162	0.725	0.980 0.970	0.236 0.224	0.02	0.04	0.01

OUTLINE VERSION	REFERENCES				EUROPEAN PROJECTION	ISSUE DATE
	IEC	JEDEC	EIAJ			
SOT171A						97-06-28

UHF power transistor

BLV97CE

DEFINITIONS

Data Sheet Status	
Objective specification	This data sheet contains target or goal specifications for product development.
Preliminary specification	This data sheet contains preliminary data; supplementary data may be published later.
Product specification	This data sheet contains final product specifications.
Limiting values	
Limiting values given are in accordance with the Absolute Maximum Rating System (IEC 134). Stress above one or more of the limiting values may cause permanent damage to the device. These are stress ratings only and operation of the device at these or at any other conditions above those given in the Characteristics sections of the specification is not implied. Exposure to limiting values for extended periods may affect device reliability.	
Application information	
Where application information is given, it is advisory and does not form part of the specification.	

LIFE SUPPORT APPLICATIONS

These products are not designed for use in life support appliances, devices, or systems where malfunction of these products can reasonably be expected to result in personal injury. Philips customers using or selling these products for use in such applications do so at their own risk and agree to fully indemnify Philips for any damages resulting from such improper use or sale.